

Polished Stainless Steel Surface Roughness of 0.8µm



ISO 9001: 2015



No 44 100 17370122

FDA APPROVED



CE MARK



ATEX



TR CU



EUROPEAN COM REGUL
1935/2004/EC



Features and Benefits

- New generation PTFE diaphragms of embodied type for long-life operation (compound) FDA Approved
- New generation EPDM diaphragms with embodied inner-outer piston FDA Approved
- Polished Stainless Steel Surface Roughness of 0.8µm
- Advanced quality Full capacity PTFE-A diaphragms FDA Approved
- RubyShine Pumps have been engineered to meet FDA CFR 21.177, 1935/2004/EC, ATEX, and CE.
- Economical air consumption, ecological designing
- Standard connections Tri-Clamp ISO
- One-piece manifold

RubyShine composition codes

Model	Pump Body	Center Section	Diaphragms	Ball Seats	Valve Ball	O-ring
RubyShine 180 DN 80 Tri-clamp	SL: Stainless Steel 316 Ra 08µm	W: PP AN: Alu Nickel Plated	Z: PTFE A+back up (EPDM Conductive) T: PTFE+back up E: EPDM Conductive	S: AISI 316	T: PTFE S: AISI 316	T: PTFE

RubyShine Air operated diaphragm pneumatic pumps are manufactured under FDA requirements. All materials in contact with the liquid comply to FDA CFR 21.177, 1935/2004/EC regulations. The whole range is in AISI 316 Polished Stainless Steel Surface Roughness of $0.8\mu\text{m}$. Additionally, PTFE and EPDM diaphragms are of new technology (Compound) with integrated piston.



Ruby Innovative oil free air valve

The heart of the RubyShine pump is our innovative, new design air valve. In respect for New Era demands, to create and offer High Quality product, with high interest for the environment and its protection, the Air Valve of the RubyShine Diaphragm Pumps has been created to offer

- ✓ Oil free operation
- ✓ No need for maintenance
- ✓ Not affected by minor contamination of compressed air
- ✓ Significant energy saving
- ✓ Non freezing operation
- ✓ External environment operation
- ✓ No dead centre
- ✓ Long life
- ✓ Reliability

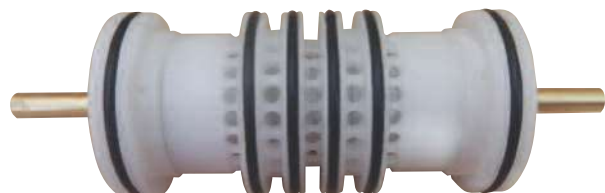

Advance unified diaphragms featuring:

- ✓ Easy installation and maintenance
- ✓ Excellent service life
- ✓ Inventory cost reduction
- ✓ Improved performance
- ✓ Greater displacement per cycle
- ✓ No center hole, elimination of potential leak paths.
- ✓ There is no need for the main axis to be insured
- ✓ They can be screwed and unscrewed without the use of tools



Advance Unified Diaphragm offers:

The prominences decrease the stretching of the PTFE during the regression and prevent it from cracking.

Innovative conical shape ideal for optimal performance and life, low pressure requirements for start-up, ideal suction

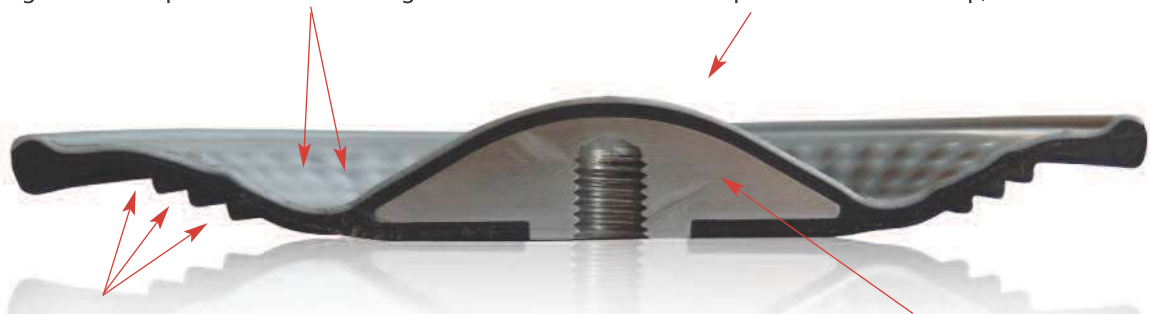

Innovative diaphragm support side, offers flexibility, long life and protects from cavitation

Special internal plate supports your diaphragm in every movement

Technical data

ATEX certification	 STANDARD : II 3G Ex h IIB T4 Gc - II 3D Ex h IIIB T135°C Dc CONDUCT : II 2G Ex h IIC T4 Gb - II 2D Ex h IIIB T135°C Db
Pump Body	Stainless Steel 316 Mirror Polish
Diaphragms	EPDM Conductive Compound PTFE+Back up EPDM conductive Compound PTFE A + Back up EPDM conductive
Suction / Discharge Connection	DN 80 tri-clamp
Air connection	3/4"
*Max. self-priming capacity	4 m
*Max. flow rate	850 l/min
Max. head	80 m
Max. air supply pressure	8 bar
Max size of solids	8,0 mm
Max. operating temp.	95°C
Weight AISI 316	88 kg

* The curves and performance values refer to pumps with submerged suction and a free delivery outlet with water at 20°C, and vary according to the construction material.

Performance

FULL CAPACITY PTFE - A FITTED

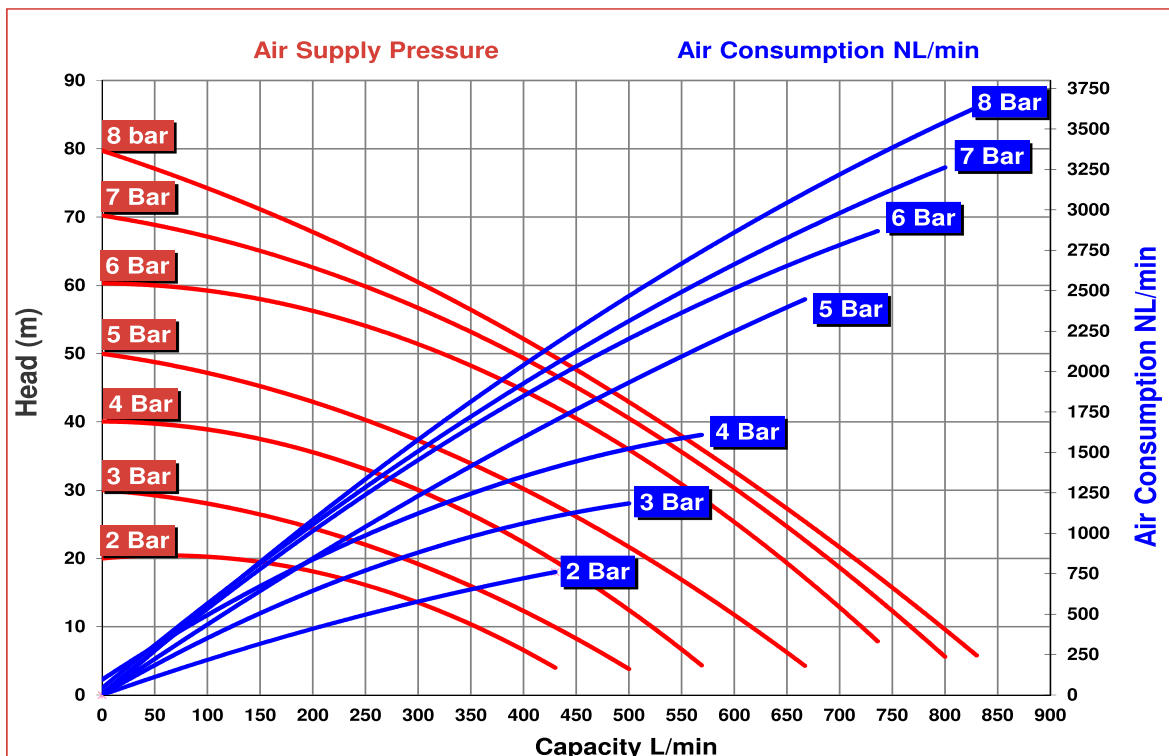



RubyShine 180 Air Operated Diaphragm Pump

PTFE FITTED

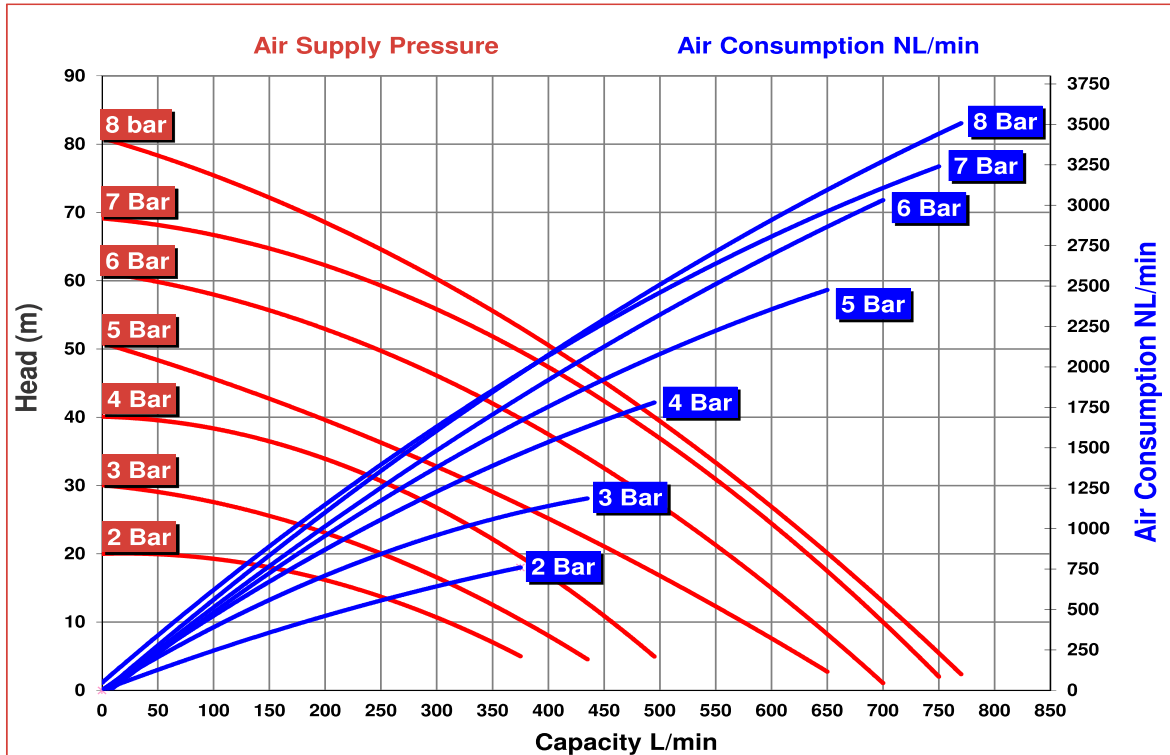

EPDM FITTED

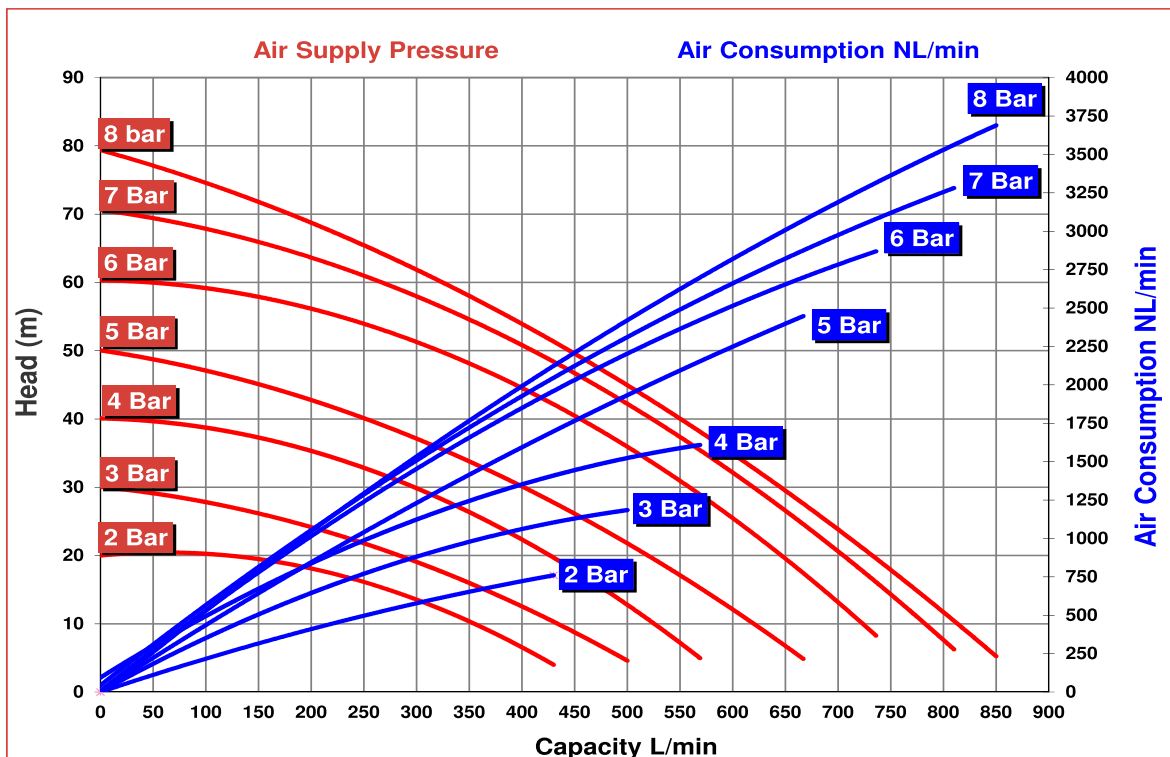

Dimensions

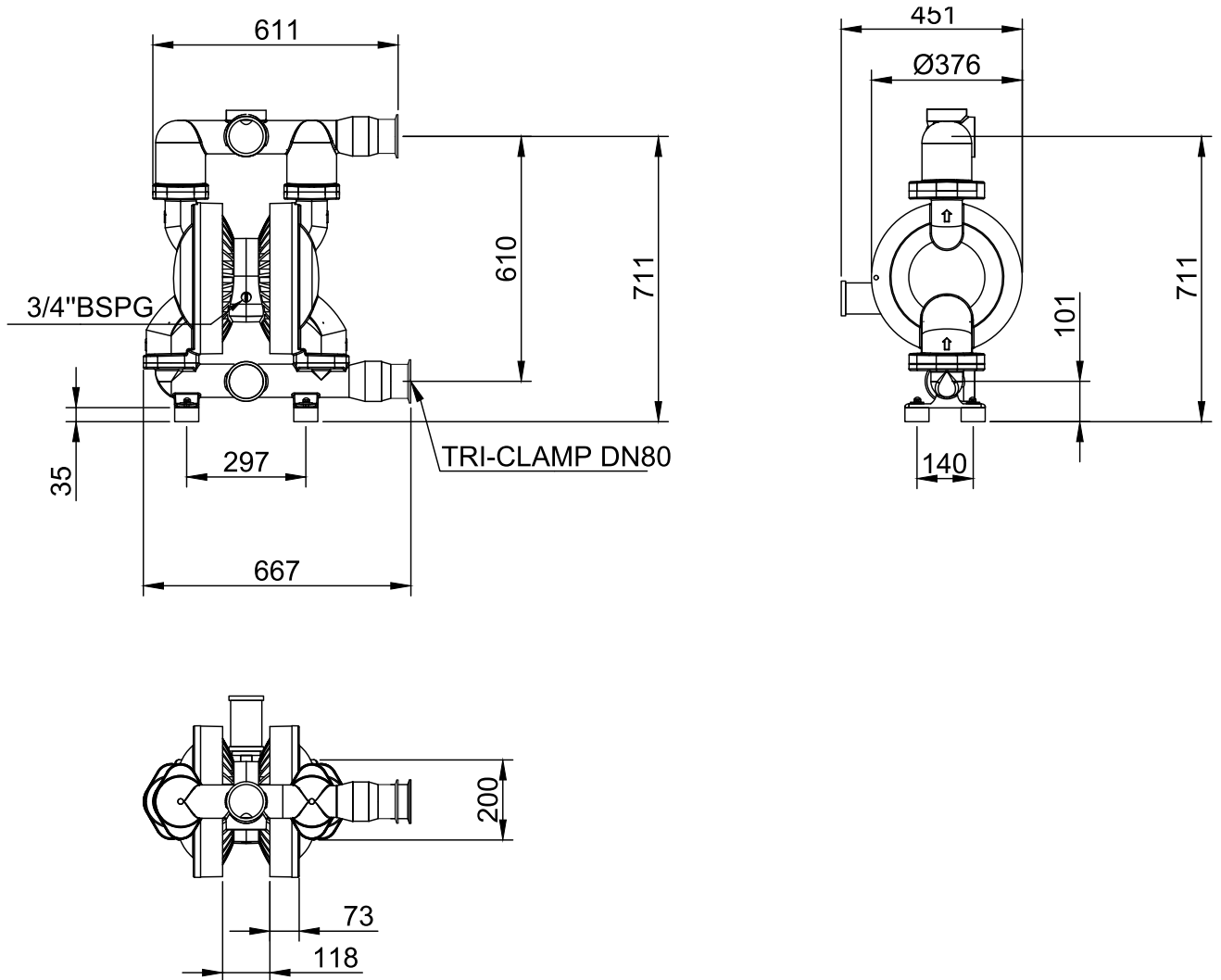



We Make The Difference

Headquarters / Factory
Inofita Industrial area
59th km Nat.Road Athens - Lamia
GR 320 11 Inofita Viotia, Greece
Tel: +30 215 215 9520, +30 215 215 9580
email: sales@alphadynamic.eu
www.alphadynamic.eu