



Construction materials: **PP , PVDF+CF , PP+CF**

New pump line with a brand new designing that offers reinforced pumping potentials. The updated designing provides even bigger performance provided with economy.



II 2/2 G/D Ex h IIC T4 Gb/Db
IM2 Ex h Mb



Benefits

- Optimal performance
- Economical air consumption, ecological designing
- High efficiency for pressure/capacity
- Oil free operation
- No freezing
- New air valve designing, fully controlled air passing
- Easy disassembling and re-assembling
- New generation diaphragms with embodied inner-outer piston
- New generation PTFE diaphragms of embodied type for long-life operation (compound)
- Advanced quality Full capacity PTFE-A diaphragms for high chemical and mechanical applications
- Potential to be submersible (on request)
- Possibility to be used in dirty environments due to their closed designing
- Easy manifold reverse
- Automatic suction
- Twin manifold option (two suction and two delivery)
- Excellent performance and value for money
- Ideal for abrasive, viscous, and shear sensitive media

Ruby 125 composition codes

Model	Pump Body	Center Section	Diaphragms	Ball Seats	Valve Ball	O-ring
Ruby 125 - 1"	P : PP V : PVDF+CF PC : PP+CF	P : PP PC : PP+CF	N : NBR Conductive E : EPDM Conductive F : VITON Conductive T : PTFE+back up (EPDM Conductive) Z : PTFE A+back up (EPDM Conductive)	V : PVDF P : PP	T : PTFE S : AISI 316 N : NBR E : EPDM	T : PTFE F : VITON E : EPDM N : NBR

Ruby Innovative oil free air valve

The heart of the Ruby pump is our innovative, new design air valve. In respect for New Era demands, to create and offer High Quality product, with high interest for the environment and it's protection, the Air Valve of the Ruby Diaphragm Pumps has been created to offer:

- ✓ Oil free operation
- ✓ Low need for maintenance
- ✓ Not affected by minor contamination of compressed air
- ✓ Significant energy saving
- ✓ Non freezing operation
- ✓ External environment operation
- ✓ No dead centre
- ✓ Long life
- ✓ Reliability

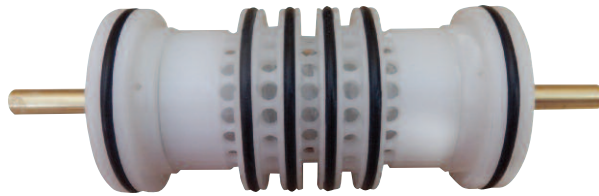

Advance unified diaphragms featuring:

- ✓ Easy installation and maintenance
- ✓ Excellent service life
- ✓ Inventory cost reduction
- ✓ Improved performance
- ✓ Greater displacement per cycle
- ✓ No center hole, elimination of potential leak paths.
- ✓ There is no need for the main axis to be insured
- ✓ They can be screwed and unscrewed without the use of tools



Advance Unified Diaphragm offers:

The prominences decrease the stretching of the PTFE during the regression and prevent it from cracking.

Innovative conical shape ideal for optimal performance and life, low pressure requirements for start-up, ideal suction

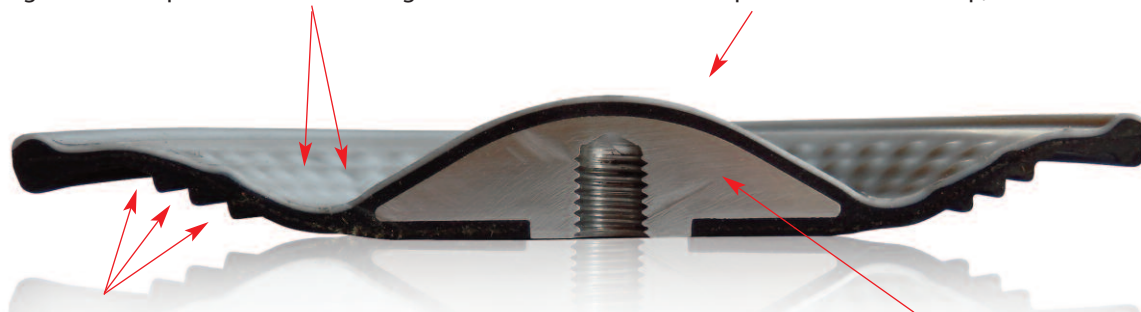

Innovative diaphragm support side, offers flexibility, long life and protects from cavitation

Special internal plate supports your diaphragm in every movement

Technical data

ATEX Certificate	CE  STANDARD : II 3/3 G/D Ex h IIB T4 Gc/Dc CONDUCT : II 2/2 G/D Ex h IIC T4 Gb/Db – I M2 Ex h Mb
Construction materials	PP, PVDF+CF, PP+CF
Diaphragms	N: NBR Conductive E: EPDM Conductive F: Viton Conductive T: Compound PTFE + Backup (EPDM Conductive) Z: Compound PTFE A + Backup (EPDM Conductive)
Intake / delivery connections :	Flange DN 25 / ANSI 25
Air connection :	1/2 "
*Max. suction head :	4 m
*Max. flow rate :	185 L/min
Max. flow pressure :	8 bar
Operating pressure :	Min. 2 bar – Max.8 bar
Max. size of solids :	3.5 mm
Max. operating Temperature :	PP : 60°C , PP+CF:60°C ,PVDF+CF : 95°C
Weight PP	7 Kg
Weight PVDF+CF	8 Kg

* The curves and performance values refer to pumps with submerged suction and a free delivery outlet with water at 20°C, and vary according to the construction material.

Performance

RUBY 126 - FULL CAPACITY PTFE - A FITTED

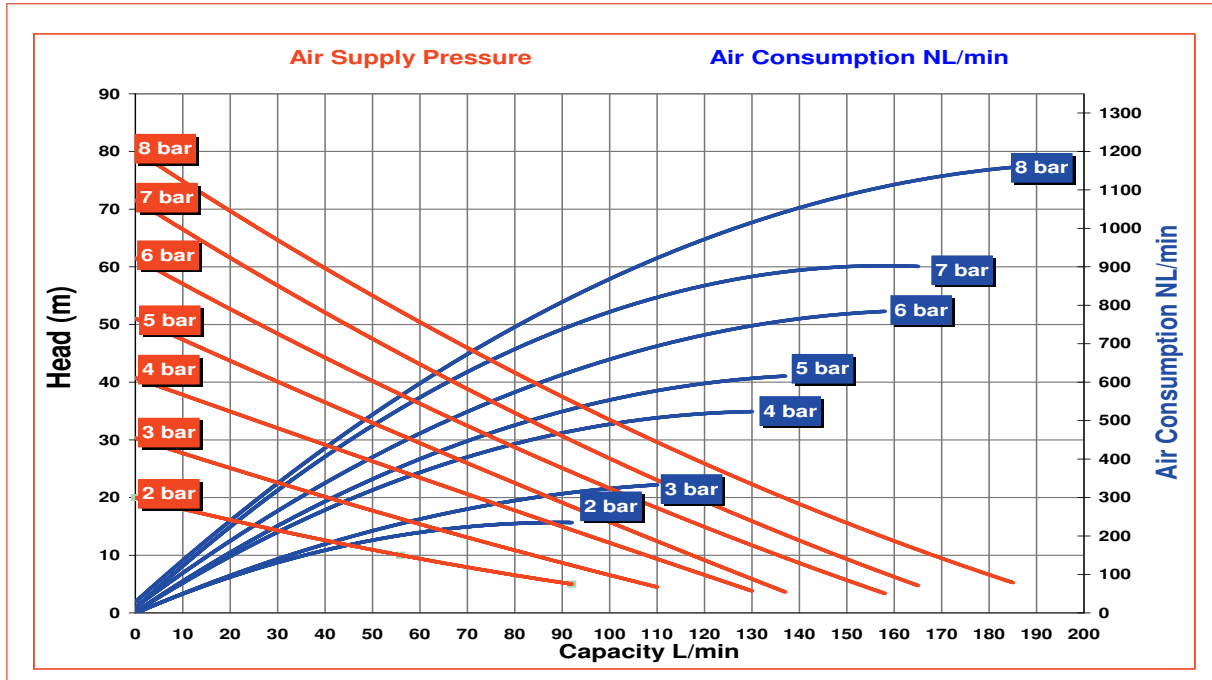

RUBY 126 - RUBBER FITTED

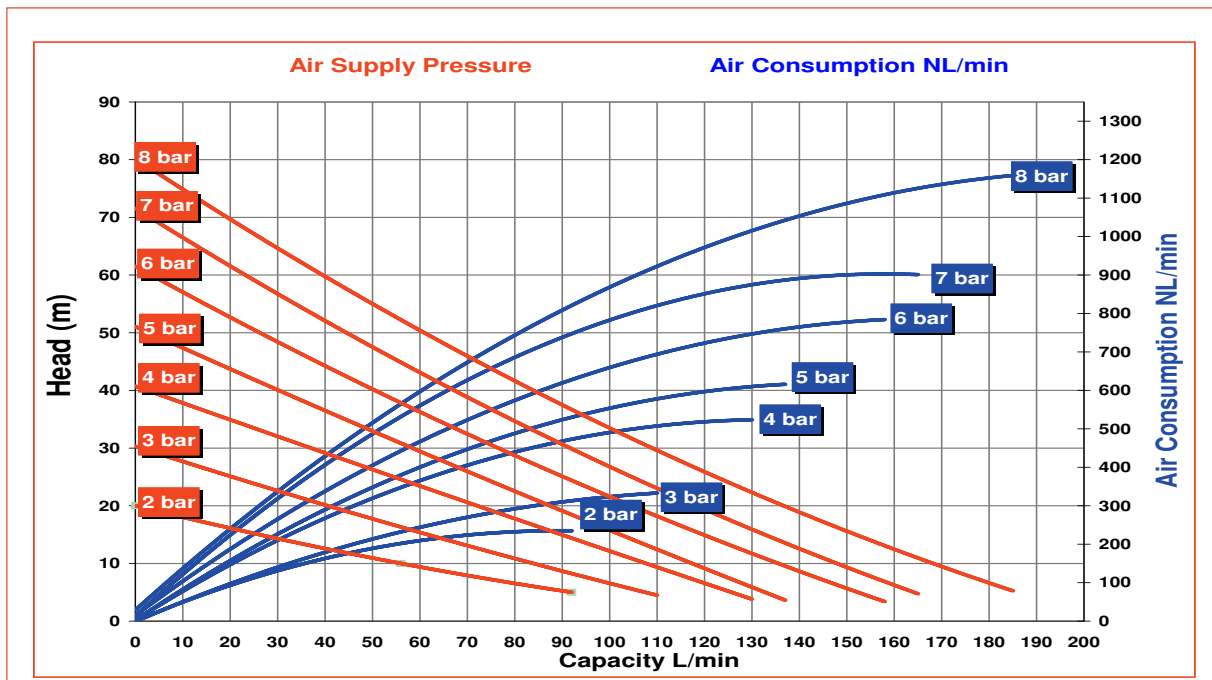

Performance

RUBY 126 - PTFE FITTED

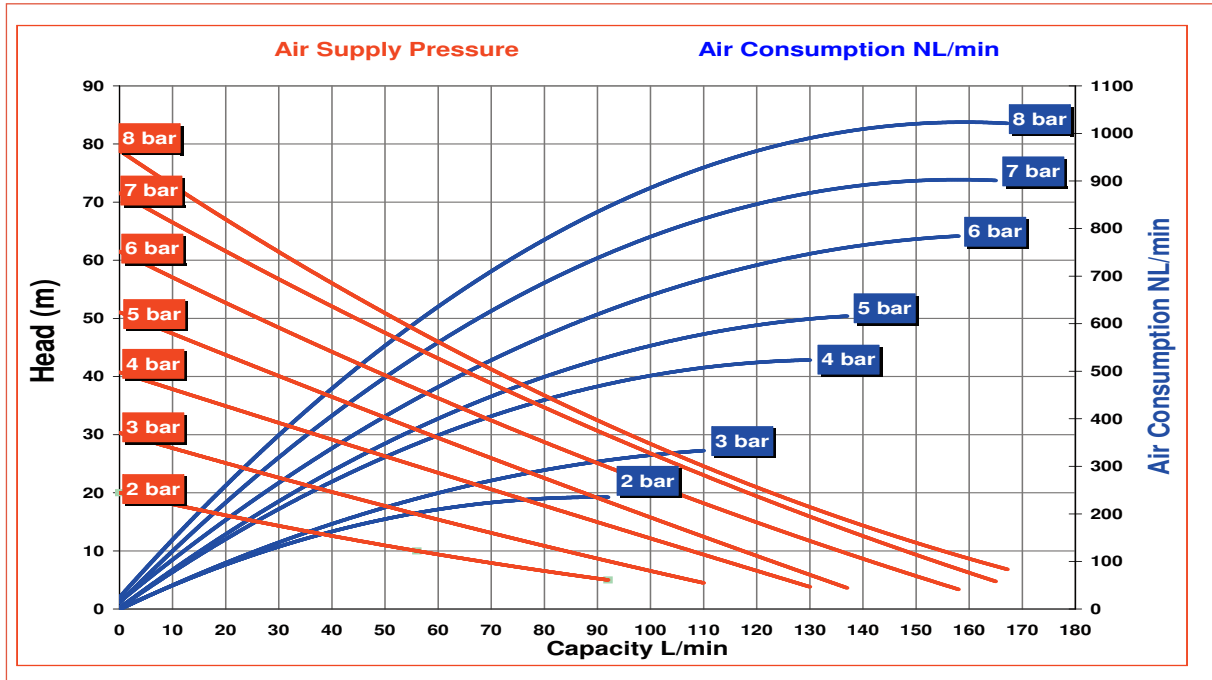

Dimensions

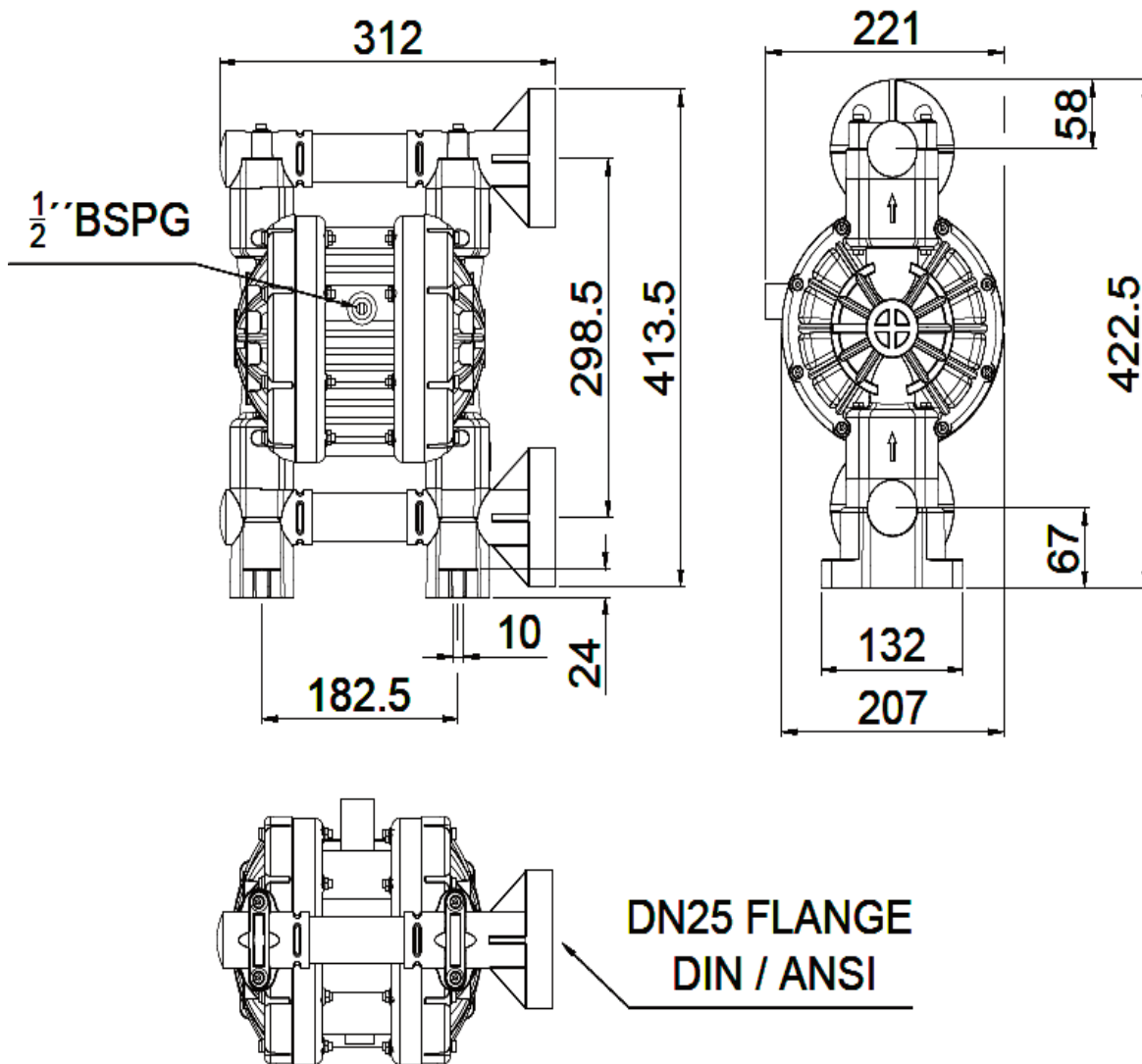



Construction materials: **PP , PVDF+CF , PP+CF**

New pump line with a brand new designing that offers reinforced pumping potentials. The updated designing provides even bigger performance provided with economy.



II 2/2 G/D Ex h IIC T4 Gb/Db
I M2 Ex h Mb



Benefits

- Optimal performance
- Economical air consumption, ecological designing
- High efficiency for pressure/capacity
- Oil free operation
- No freezing
- New air valve designing, fully controlled air passing
- Easy disassembling and re-assembling
- New generation diaphragms with embodied inner-outer piston
- New generation PTFE diaphragms of embodied type for long-life operation (compound)
- Advanced quality Full capacity PTFE-A diaphragms for high chemical and mechanical applications
- Potential to be submersible (on request)
- Possibility to be used in dirty environments due to their closed designing
- Easy manifold reverse
- Automatic suction
- Twin manifold option (two suction and two delivery)
- Excellent performance and value for money
- Ideal for abrasive, viscous, and shear sensitive media

Ruby 125 composition codes

Model	Pump Body	Center Section	Diaphragms	Ball Seats	Valve Ball	O-ring
Ruby 125 - 1"	P : PP V : PVDF+CF PC : PP+CF	P : PP PC : PP+CF	N : NBR Conductive E : EPDM Conductive F : VITON Conductive T : PTFE+back up (EPDM Conductive) Z : PTFE A+back up (EPDM Conductive)	V : PVDF P : PP	T : PTFE S : AISI 316 N : NBR E : EPDM	T : PTFE F : VITON E : EPDM N : NBR

Ruby Innovative oil free air valve

The heart of the Ruby pump is our innovative, new design air valve. In respect for New Era demands, to create and offer High Quality product, with high interest for the environment and it's protection, the Air Valve of the Ruby Diaphragm Pumps has been created to offer:

- ✓ Oil free operation
- ✓ Low need for maintenance
- ✓ Not affected by minor contamination of compressed air
- ✓ Significant energy saving
- ✓ Non freezing operation
- ✓ External environment operation
- ✓ No dead centre
- ✓ Long life
- ✓ Reliability

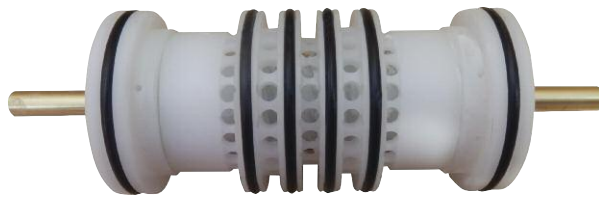

Advance unified diaphragms featuring:

- ✓ Easy installation and maintenance
- ✓ Excellent service life
- ✓ Inventory cost reduction
- ✓ Improved performance
- ✓ Greater displacement per cycle
- ✓ No center hole, elimination of potential leak paths.
- ✓ There is no need for the main axis to be insured
- ✓ They can be screwed and unscrewed without the use of tools



Advance Unified Diaphragm offers:

The prominences decrease the stretching of the PTFE during the regression and prevent it from cracking.

Innovative conical shape ideal for optimal performance and life, low pressure requirements for start-up, ideal suction

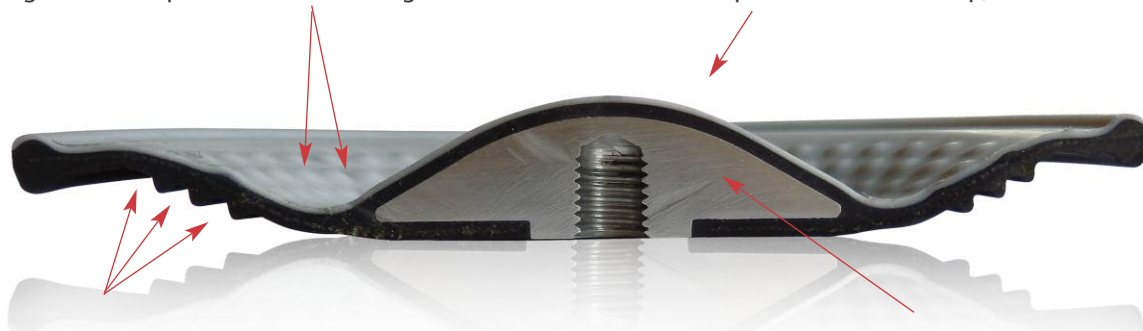

Innovative diaphragm support side, offers flexibility, long life and protects from cavitation

Special internal plate supports your diaphragm in every movement

Technical data

ATEX Certificate	CE  STANDARD : II 3/3 G/D Ex h IIB T4 Gc/Dc CONDUCT : II 2/2 G/D Ex h IIC T4 Gb/Db – I M2 Ex h Mb
Construction materials	PP, PVDF+CF, PP+CF
Diaphragms	N: NBR Conductive E: EPDM Conductive F: Viton Conductive T: Compound PTFE + Backup (EPDM Conductive) Z: Compound PTFE A + Backup (EPDM Conductive)
Intake / delivery connections :	1 " BSP F
Air connection :	1/2 "
*Max. suction head :	4 m
*Max. flow rate :	185 L/min
Max. flow pressure :	8 bar
Operating pressure :	Min. 2 bar – Max.8 bar
Max. size of solids :	3.5 mm
Max. operating Temperature :	PP : 60°C , PP+CF:60°C ,PVDF+CF : 95°C
Weight PP	6 Kg
Weight PVDF+CF	7 Kg

* The curves and performance values refer to pumps with submerged suction and a free delivery outlet with water at 20°C, and vary according to the construction material.

Performance

RUBY 125 - FULL CAPACITY PTFE - A FITTED

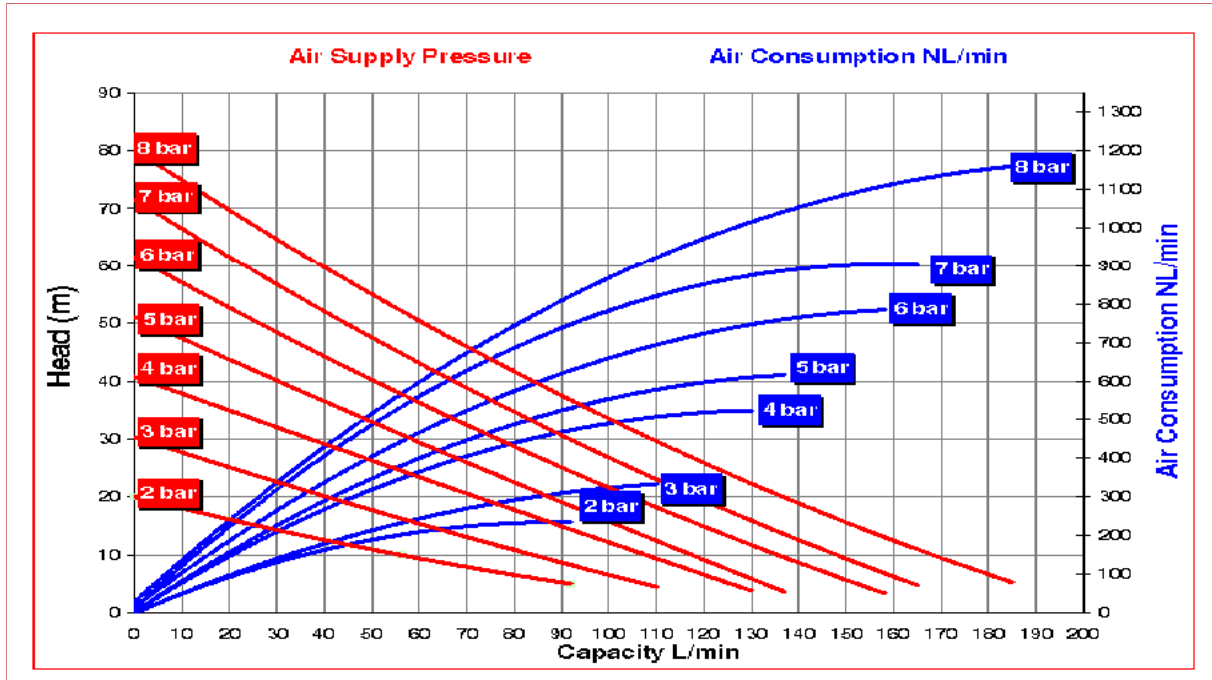

RUBY 125 - RUBBER FITTED

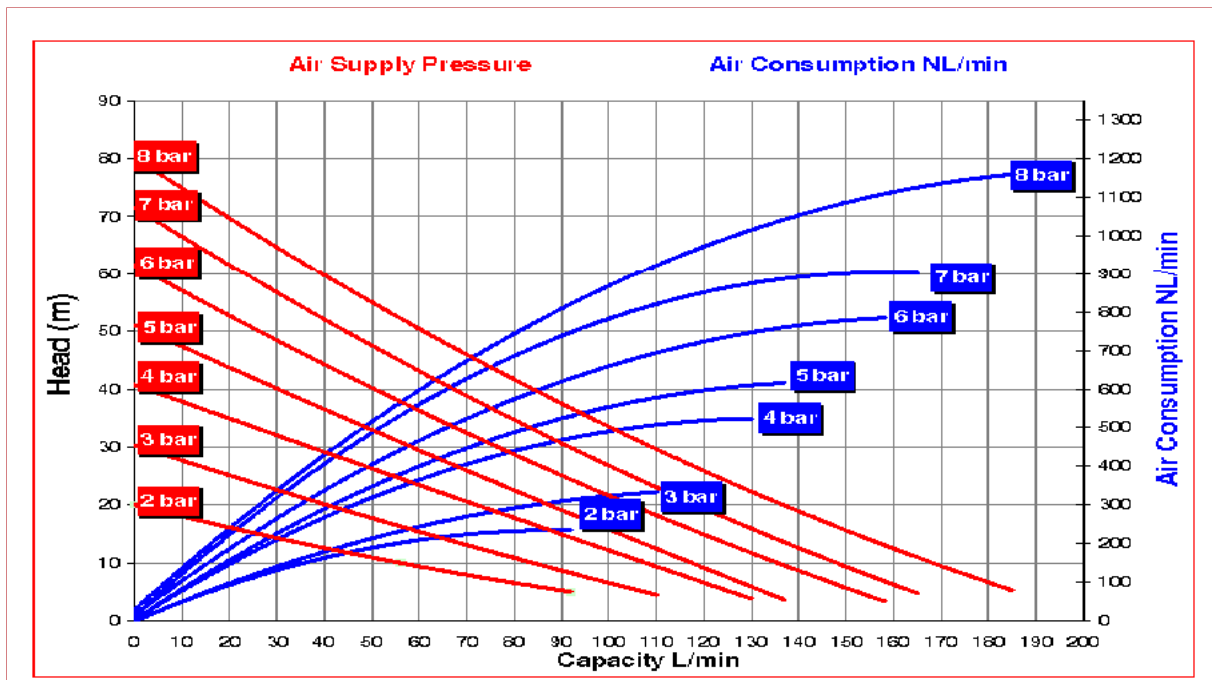

Performance

RUBY 125 - PTFE FITTED

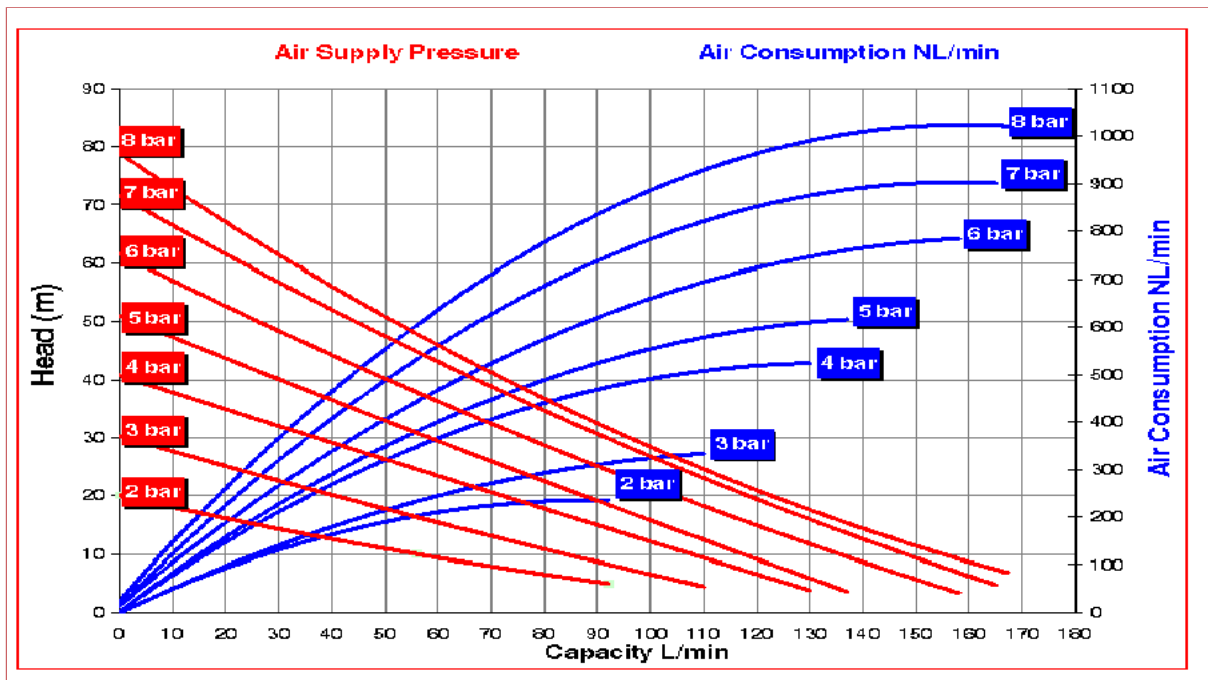

Dimensions

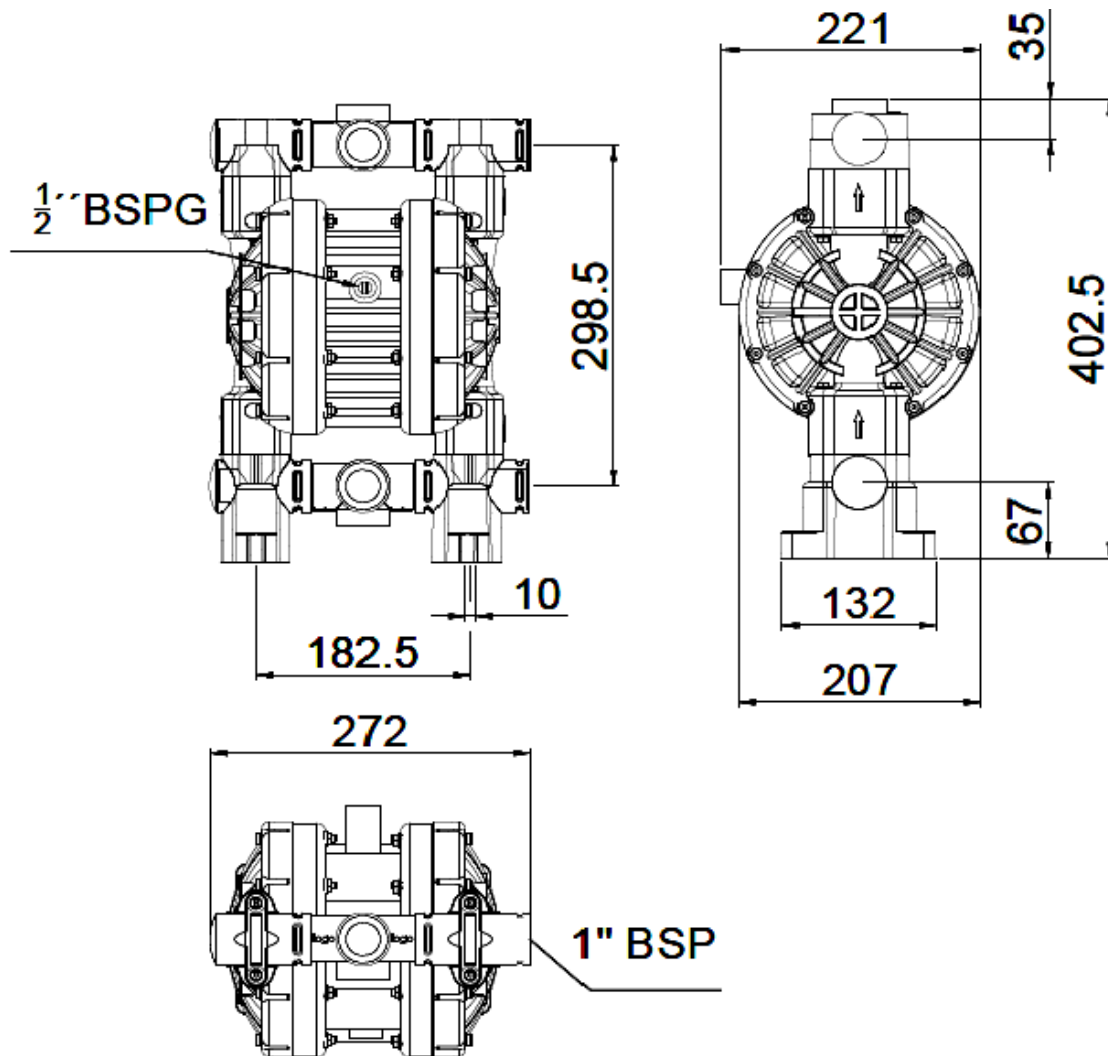

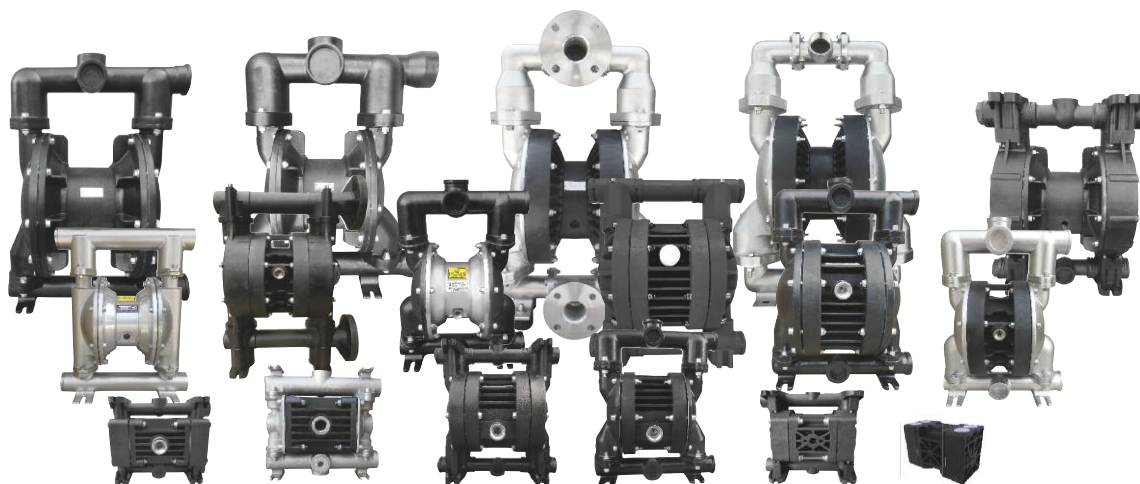

We Make The Difference



Production Plant - Greece

Inofita Industrial area
59th km Nat.Road Athens- Lamia
GR 320 11 Inofita Viotia, Greece
Tel +30 215 215 9520 , +30 215 215 9580
Email: Sales@alphadynamic.eu
www.alphadynamic.eu

Sales Office – England

Rockleigh House, 37 Burton Road
Ashby de la Zouch , Leicestershire
LE65 2LF - United Kingdom (UK)
Registered in ENGLAND & WALES
Registration number 09706219
Tel +44 1213 680 324 , +44 1213 680472
Email: Sales@alphadynamic.eu
www.alphadynamic.eu